

variety inox®

a c e r o   i n o x i d a b l e



**variety** inox®

a c e r o   i n o x i d a b l e

# Índice

Calidad Variety	3
Manillas macizas	6
Tiradores macizos	11
Manillas tubulares	14
Tiradores tubulares	20
Accesorios	23
Accesorios baño	28
Estructuras modulares	32
Bisagras y pernios	37
Picaportes y cerraduras	40
Tiradores para mueble	42



## Calidad Variety

Variety inox ofrece una amplia gama de herrajes fabricados en acero inoxidable.

Manillas y manillones macizos, que nos permite crear modernos y elaborados diseños para los proyectos arquitectónicos y decorativos más vanguardistas. Manillas y tiradores tubulares con diseños funcionales, limpios y minimalistas, que se complementan con gran variedad de placas y rosetas.

Además, contamos con todos los accesorios necesarios para puertas, como bocallaves, condenas, topes, pernios y bisagras, cerraduras y picaportes, sin dejar de lado la aplicación del acero inoxidable en baños con nuestros herrajes para estructuras modulares, barras de apoyo y accesorios para cuartos de baño.

Todo fabricado en acero inoxidable austenítico 304 de alta calidad y gran poder anticorrosivo, con acabado satinado, manteniendo altos estándares en la producción y el diseño.



# Manillas y tiradores

La gama de manillas y tiradores Variety Inox se clasifican en dos categorías: macizos y tubulares. La gama maciza se caracteriza por estar fabricada con acero sólido, lo que le confiere mayor peso y una mayor variedad de diseños. La gama tubular es más ligera, ya que no es un material sólido y, debido a su proceso de fabricación, los diseños de los modelos son más técnicos y sencillos.

La gama maciza es perfecta para proyectos decorativos y arquitectónicos de mayor perfil creativo, mientras que la gama tubular es ideal para soluciones más técnicas, que buscan limpieza de líneas y pulcritud de formas.



Busque en nuestras manillas nuestro símbolo de calidad



Nuestras manillas y tiradores incluyen todos los elementos necesarios para su montaje.

## Elementos manillas Variety Inox

- ① Manilla (2udes.)
- ② Tornillo hexagonal (2udes.)
- ③ Cuadradillo 8mm. (1ud.)
- ④ Roseta (2udes.)
- ⑤ Tornillo pasante autocortante (1ud.)
- ⑥ Llave Allen (1ud.)
- ⑦ Tornillo rosca madera (4udes.)

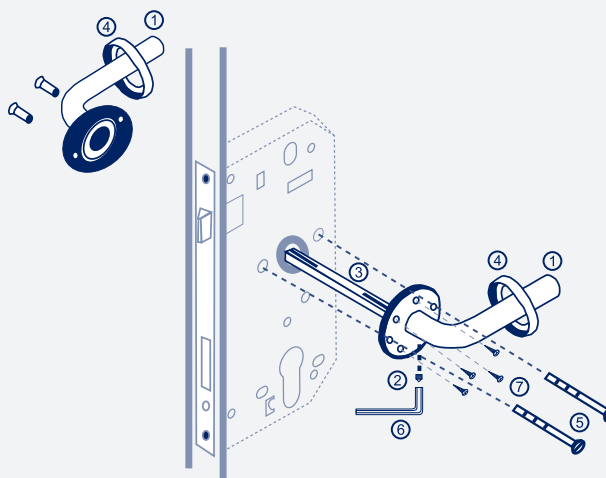

Dependiendo del modelo de manilla o tirador, vendrá montada con uno de nuestros tres tipos de roseta: estándar, roscada o cuadra.



## Kit de montaje para tiradores tubulares

El kit de montaje para tiradores tubulares Variety Inox, da la opción de montaje en puertas de madera o cristal.

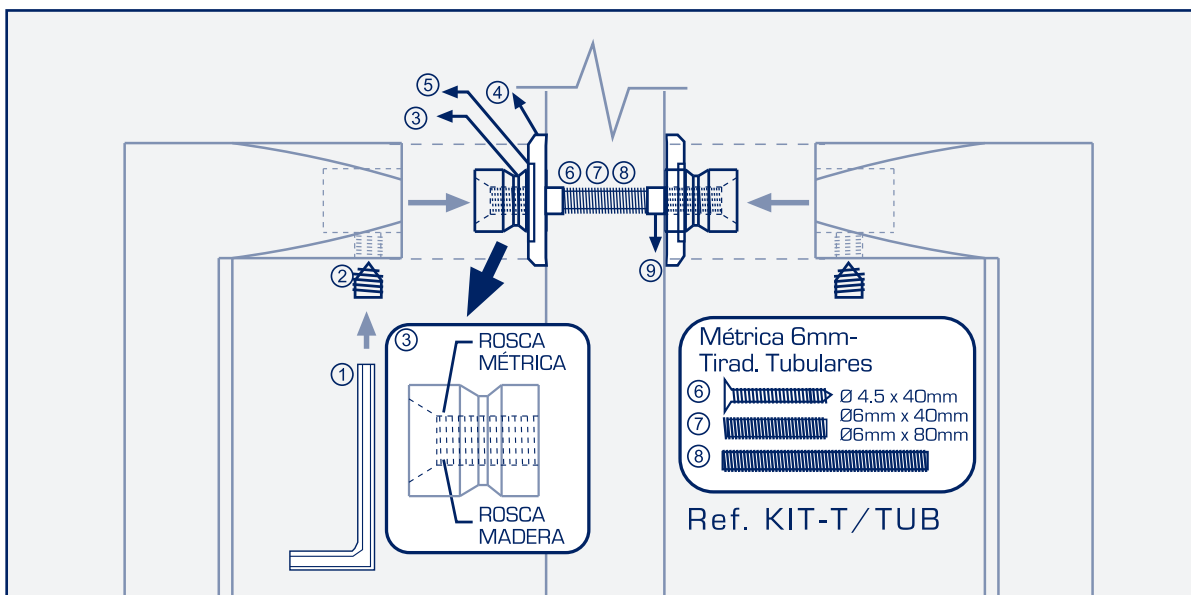

- |                               |                                   |                                |
|-------------------------------|-----------------------------------|--------------------------------|
| ① Llave Allen (1ud.)          | ④ Roseta embellecedora (4udes.)   | ⑦ Esparrago 40mm M6 (2udes.)   |
| ② Tornillo hexagonal (2udes.) | ⑤ Protector transparente (4udes.) | ⑧ Esparrago 80mm M6 (2udes.)   |
| ③ Conector (4udes.)           | ⑥ Tornillo rosca madera (4udes.)  | ⑨ Protector esparrago (4udes.) |

El kit incluye miniroseta embellecedora de Ø30mm. Opción de usar el set de roseta de Ø45mm (ver página 21).



Miniroseta Ø30mm incluida en el kit

Set de roseta Ø45mm para tirador tubular. (Opcional).  
Código: 26537.  
Ref.: ROS-T/TUB



# Manillas macizas

Júpiter	7
Aristeo	7
Jano	7
Proteo	7
Titán	8
Glauco	8
Marte	8
Vesta	8
Neptuno	9
Cibeles	9
Fauno	9
Hércules	9
Silvano	10
Minerva	10
Mitra	10



# Júpiter



Referencia: Jupiter  
Código: 20943  
Roseta estándar

1 jgo.

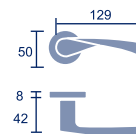

# Aristeo



Referencia: Aristeo  
Código: 23088  
Roseta maciza

1 jgo.

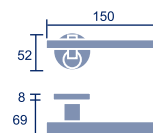

# Jano



Referencia: Jano  
Código: 23089  
Roseta maciza

1 jgo.

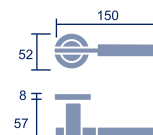

# Proteo



Referencia: Proteo  
Código: 23091  
Roseta maciza

1 jgo.

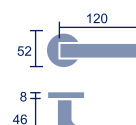

# Titán



Referencia: Titan  
Código: 23515  
Roseta cuadrada

1 jgo.

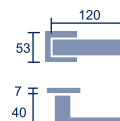

# Glauco



Referencia: Glauco  
Código: 23095  
Roseta maciza

1 jgo.

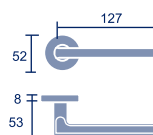

# Marte



Referencia: Marte  
Código: 22771  
Roseta maciza

1 jgo.

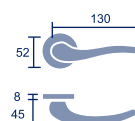

# Vesta



Referencia: Vesta  
Código: 22772  
Roseta maciza

1 jgo.

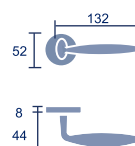

# Neptuno



Referencia: Neptuno  
Código: 20942  
Roseta estándar

 1 jgo.

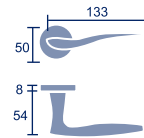

# Cibeles



Referencia: Cibeles  
Código: 21375  
Roseta estándar

 1 jgo.

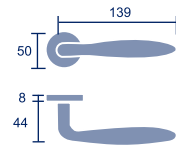

# Fauno



Referencia: Fauno  
Código: 22122  
Roseta estándar

 1 jgo.

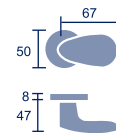

# Hércules



Referencia: Hércules  
Código: 20945  
Roseta estándar

 1 jgo.

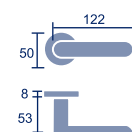

# Silvano



Referencia: Silvano  
Código: 20946  
Roseta estándar

1 jgo.

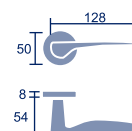

# Minerva



Referencia: Minerva  
Código: 21374  
Roseta estándar

1 jgo.

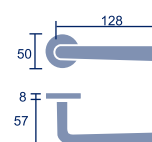

# Mitra



Referencia: Mitra  
Código: 26525  
Roseta cuadrada

1 jgo.

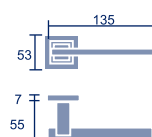



# Tiradores macizos

Hércules	12
Titán	12
Jano	12
Vesta	12
Cibeles	12
Glauco	13
Glauco-C	13
Júpiter 250mm	13
Júpiter 200mm	13

## Hércules

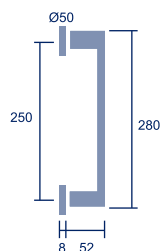

Referencia: T/Hercules  
Código: 22125  
Roseta estándar  
1 ud.

## Titán

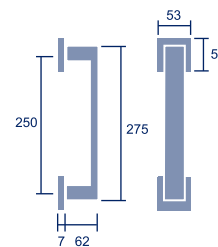

Referencia: T/Titan  
Código: 25328  
Roseta cuadrada  
1 ud.

## Jano

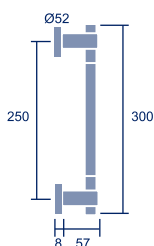

Referencia: T/Jano  
Código: 23094  
Roseta maciza  
1 ud.

## Vesta

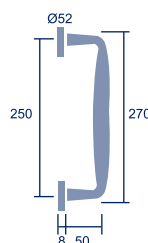

Referencia: T/Vesta  
Código: 23087  
Roseta maciza  
1 ud.

## Cibeles

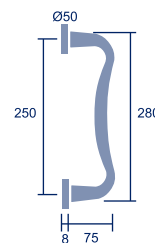

Referencia: T/Cibeles  
Código: 22123  
Roseta estándar  
1 ud.

## Glauco



E	L
200	225
250	275

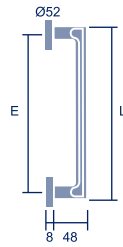

Referencia: T/Glauco-200  
Código: 23575

Referencia: T/Glauco-250  
Código: 23096  
Roseta maciza

1 ud.

## Glauco-C

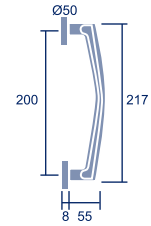

Referencia: T/Glauco-C  
Código: 25644  
Roseta estándar

1 ud.

## Júpiter. 250mm

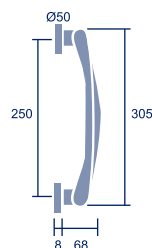

Referencia: T/Jupiter-250  
Código: 23086  
Roseta estándar

1 ud.

## Júpiter. 200mm

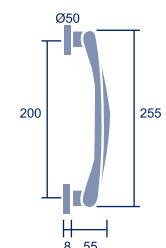

Referencia: T/Jupiter-200  
Código: 25643  
Roseta estándar

1 ud.



# Manillas tubulares

Juno	15
Plutón	16
Tellus	17
Belona	16
Talía	18
Iris	18
Ceres	18
Baco	19
Cubo	19
Kit de placas	19



# Juno

Referencia: Juno'19

Código: 25224

Roseta estándar

1 jgo.

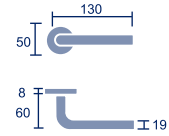

Referencia: Juno'19/MR

Código: 26868

Roseta 25mm

1 jgo.

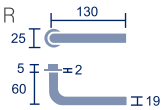

Referencia: Juno'19/RO

Código: 26869

Roseta ovalada

1 jgo.

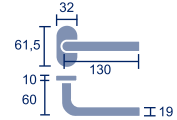

Referencia: Juno'19/O

Código: 25225

Placa ovalada

1 jgo.



Referencia: Juno'19/R

Código: 25226

Placa rectangular

1 jgo.



Referencia: Juno'19/V

Código: 25229

Manilla ventana

1 ud.

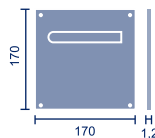
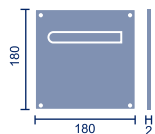
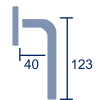

Referencia: Juno'19/C18

Código: 25227

Placa cuad. 180mm

1 jgo.

Referencia: Juno'19/C17

Código: 25228

Placa cuad. 170mm

1 jgo.

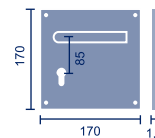
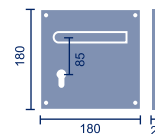

Referencia: Juno'19/C18Y

Código: 26881

Placa cuad. 180mm

1 jgo.

Referencia: Juno'19/C17Y

Código: 26882

Placa cuad. 170mm

1 jgo.

# Plutón

Referencia: Plutón'19

Código: 25230

Roseta estándar

1 jgo.

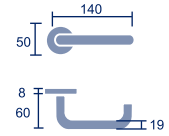

Referencia: Plutón'19/MR

Código: 26870

Roseta 25mm

1 jgo.

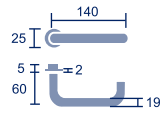

Referencia: Plutón'19/RO

Código: 26871

Roseta ovalada

1 jgo.

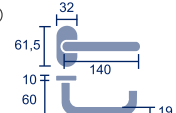

Referencia: Plutón'19/O

Código: 25231

Placa ovalada

1 jgo.



Referencia: Plutón'19/R

Código: 25232

Placa rectangular

1 jgo.



Referencia: Plutón'19/V

Código: 25235

Manilla ventana

1 ud.



Referencia: Plutón'19/C18

Código: 25233

Placa cuad. 180mm

1 jgo.

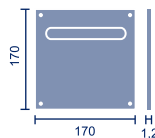
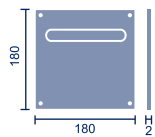

Referencia: Plutón'19/C17

Código: 25234

Placa cuad. 170mm

1 jgo.



Referencia: Plutón'19/C18Y

Código: 26883

Placa cuad. 180mm

1 jgo.

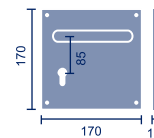
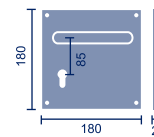

Referencia: Plutón'19/C17Y

Código: 26884

Placa cuad. 170mm

1 jgo.

# Tellus

Referencia: Tellus'19

Código: 25236

Roseta estándar

 1 jgo.

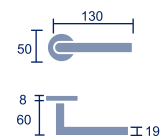

Referencia: Tellus'19/MR

Código: 26880

Roseta 25mm

 1 jgo.

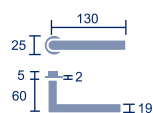

Referencia: Tellus'19/RO

Código: 26887

Roseta ovalada

 1 jgo.

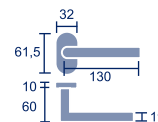

Referencia: Tellus'19/O

Código: 26888

Placa ovalada

 1 jgo.



Referencia: Tellus'19/R

Código: 26889

Placa rectangular

 1 jgo.



Referencia: Tellus'19/V

Código: 26894

Manilla ventana

 1 ud.

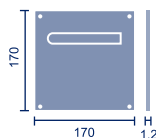
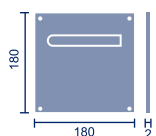

Referencia: Tellus'19/C18

Código: 26890

Placa cuad. 180mm

 1 jgo.

Referencia: Tellus'19/C17

Código: 26891

Placa cuad. 170mm

 1 jgo.

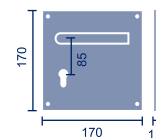
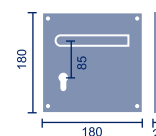

Referencia: Tellus'19/C18Y

Código: 26892

Placa cuad. 180mm

 1 jgo.

Referencia: Tellus'19/C17Y

Código: 26893

Placa cuad. 170mm

 1 jgo.

## Belona



Referencia: Belona'19  
Código: 25237  
Roseta estándar

1 jgo.

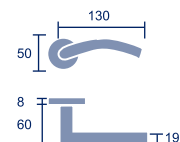

## Talía



Referencia: Talía'19  
Código: 25240  
Roseta estándar

1 jgo.

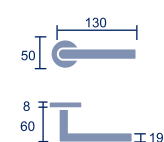

## Iris



Referencia: Iris'19  
Código: 25239  
Roseta estándar

1 jgo.

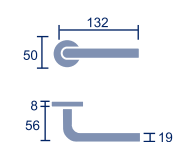

## Ceres



Referencia: Ceres'19  
Código: 25238  
Roseta estándar

1 jgo.

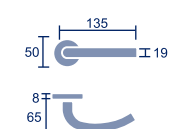



# Baco



Referencia: Baco´19  
 Código: 26549  
 Roseta cuadrada

1 jgo.

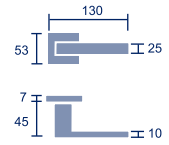

# Cubo



Referencia: Cubo´19  
 Código: 24345  
 Roseta cuadrada

1 jgo.

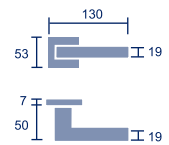

# Kit de placas

Los kits de placas dan la posibilidad de montar cualquier diseño de manilla en placa rectangular u ovalada.



Referencia: R220  
 Código: 23107  
 Placa rectangular  
 1 jgo.



Referencia: O226  
 Código: 23106  
 Placa ovalada  
 1 jgo.



Cada kit incluye todas las piezas necesarias para fijar las manillas a las placas.

# Tiradores tubulares

Set Recto (de 200 a 610mm)	21
Set recto mod. Tellus (de 200 a 500mm)	21
Set recto mod. Cubo (de 200 a 500mm)	21
Set circular (200 y 305mm)	21
Roseta para set de tiradores	21
Set curvo sin roseta (610mm)	22
Curvo con roseta (610mm)	22
Con placa rectangular	22
Con placa ovalada	22
Con placa cuadrada	22



**Set tirador tubular recto**

Incluye kit de montaje con roseta embellecedora para puerta de madera y cristal.

200mm	Código: 26508	Referencia: TR/200'19
250mm	Código: 26509	Referencia: TR/250'19
300mm	Código: 26510	Referencia: TR/300'19
400mm	Código: 26511	Referencia: TR/400'19
500mm	Código: 26512	Referencia: TR/500'19
610mm	Código: 20959	Referencia: TR/610'19

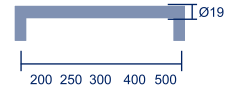

**Set tirador tubular recto. Mod. Tellus**

Incluye kit de montaje con roseta embellecedora para puerta de madera y cristal.

200mm	Código: 26514	Referencia: T/TELLUS/200'19
250mm	Código: 26515	Referencia: T/TELLUS/250'19
300mm	Código: 26516	Referencia: T/TELLUS/300'19
400mm	Código: 26517	Referencia: T/TELLUS/400'19
500mm	Código: 26518	Referencia: T/TELLUS/500'19

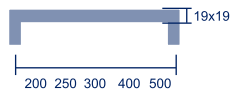
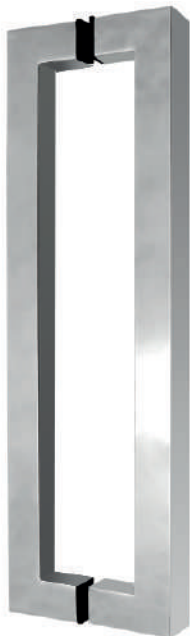

**Set tirador tubular recto. Mod. Cubo**

Incluye kit de montaje con roseta embellecedora para puerta de madera y cristal.

200mm	Código: 26520	Referencia: T/CUBO/200'19
250mm	Código: 26521	Referencia: T/CUBO/250'19
300mm	Código: 26522	Referencia: T/CUBO/300'19
400mm	Código: 26523	Referencia: T/CUBO/400'19
500mm	Código: 26524	Referencia: T/CUBO/500'19

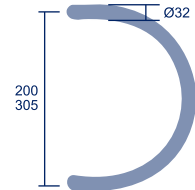

**Set tirador tubular circular**  
Sin roseta.

200mm	Código: 20948	Referencia: TC/200
305mm	Código: 20949	Referencia: TC/305



**Roseta para set de tiradores**  
Adaptable a kit de montaje.  
Referencia: ROS-T/TUB  
Código: 26537

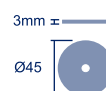

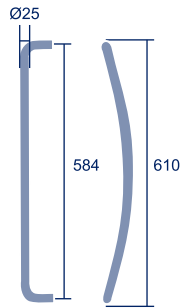

Set Tirador tubular curvo  
Sin roseta.  
Referencia: TC/610  
Código: 20950

1 set

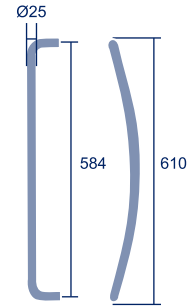

Tirador tubular curvo  
Con roseta.  
Referencia: TC/610R  
Código: 21386

1 ud.

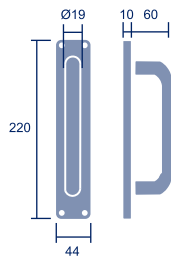

Tirador tubular recto  
Placa rectangular.  
Referencia: T/R220'19  
Código: 26543

1 ud.

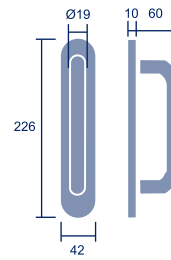

Tirador tubular recto  
Placa ovalada.  
Referencia: T/O226'19  
Código: 26542

1 ud.

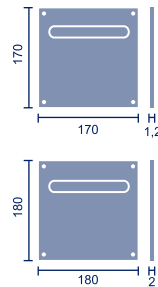

Tirador tubular recto  
Placa cuadrada  
Referencia: T/C170'19  
Código: 26885  
Placa cuad. 170mm.

2 udes.

Referencia: T/C180'19  
Código: 26544  
Placa cuad. 180mm.

2 udes.



# Accesorios

Pomos fijos	24
Bocallaves	24
Condenas y desbloques	25
Señalización	26
Pasadores	26
Soportes pasamanos	26
Topes de puerta	27
Placa de limpieza	27
Pestillo y condena sobreponer	27
Retenedor	27
Tornillo embellecedor	27

# Pomos fijos



Pomo bola puerta entrada  
Referencia: PE/70-inox  
Código: 25497

1 ud.

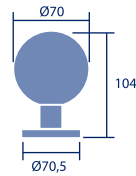

Pomo bola puerta entrada  
Referencia: PE/60-inox  
Código: 21384

1 ud.

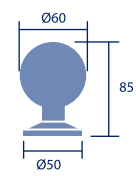

Pomo ovalado puerta entrada  
Referencia: PE/70-O/inox  
Código: 25641

1 ud.

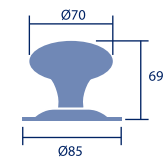

Pomo clásico puerta entrada  
Referencia: PE/70-C/inox  
Código: 25642

1 ud.

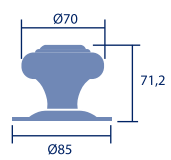

Pomo cuadrado puerta entrada  
Referencia: PE/60C-inox  
Código: 26555

1 ud.

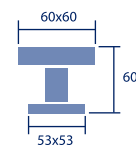

Pomo bola puerta entrada  
SOBREPONER  
Referencia: PE/70SOB-INOX  
Código: 26936

1 ud.

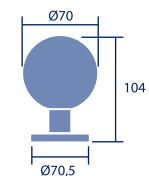

# Bocallaves



Bocallave yale redondo  
Referencia: IO09  
Código: 21136  
Roseta estándar

20 udes.



Bocallave borja redondo  
Referencia: IO05  
Código: 21371  
Roseta estándar

20 udes.



Bocallave yale redondo  
Referencia: IO13  
Código: 23114  
Roseta maciza

10 udes.



Bocallave borja redondo  
Referencia: IO14  
Código: 23115  
Roseta maciza

10 udes.







Bocallave yale cuadrado  
Referencia: I011-N  
Código: 26366  
Roseta cuadrada

20 udes.

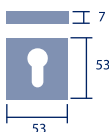

Bocallave borja cuadrado  
Referencia: I012-N  
Código: 26901  
Roseta cuadrada

20 udes.

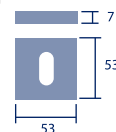

Bocallave ovalado  
Referencia: I025  
Código: 26872

30 udes.

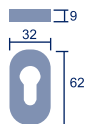

Bocallave escudo ciego  
Referencia: I022  
Código: 26873

30 udes.



Bocallave yale minroseta  
Referencia: I027  
Código: 26897

50 udes.

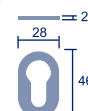

## Condenas y desbloques



Condena con desbloqueo 50mm  
Referencia: I2285AI-L  
Código: 20511  
Roseta estándar

1 jgo.



Condena con desbloqueo 53mm  
Referencia: I2295  
Código: 23111  
Roseta cuadrada

1 jgo.

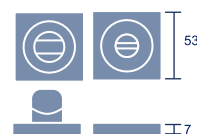

Condena con desbloqueo 50mm L/O  
Referencia: I2285L-O  
Código: 20512  
Roseta estándar

1 jgo.



Condena con desbloqueo 52mm  
Referencia: I2280  
Código: 23112  
Roseta maciza

1 jgo.



Condena con desbloqueo 35mm  
Referencia: I2270AI  
Código: 23388  
Roseta estándar

1 jgo.

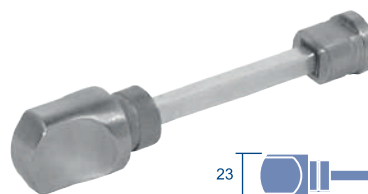

Muletilla con desbloqueo  
Referencia: I2281AI  
Código: 21385  
Roseta estándar

10 udes.



Condena con desbloqueo 50mm Discap.  
Referencia: I2285DIS  
Código: 20956  
Roseta estándar

1 jgo.

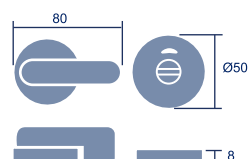



Condensa con desbloqueo 25mm  
Referencia: I2285MR  
Código: 26896

10 udes.

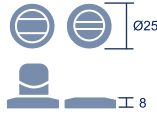

Bocallave yale tirador  
Referencia: IO10  
Código: 22128

10 udes.

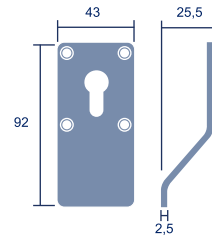

## Señalización

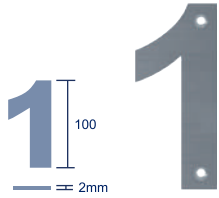

Código: 25956 Referencia: **N0**/100inox  
Código: 25957 Referencia: **N1**/100inox  
Código: 25958 Referencia: **N2**/100inox  
Código: 25959 Referencia: **N3**/100inox  
Código: 25960 Referencia: **N4**/100inox  
Código: 25961 Referencia: **N5**/100inox  
Código: 25962 Referencia: **N6**/100inox  
Código: 25963 Referencia: **N7**/100inox  
Código: 25964 Referencia: **N8**/100inox  
Código: 25965 Referencia: **N9**/100inox

5 udes.

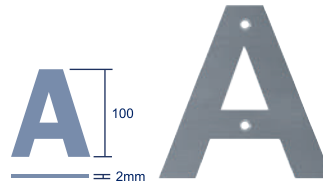

Código: 25966 Referencia: **LA**/100inox  
Código: 25967 Referencia: **LB**/100inox  
Código: 25968 Referencia: **LC**/100inox  
Código: 25969 Referencia: **LD**/100inox  
Código: 25970 Referencia: **LE**/100inox  
Código: 25971 Referencia: **LF**/100inox

5 udes.



Hombres Código: 20951 Referencia: IO01  
Mujeres Código: 20952 Referencia: IO02  
Mujer/hombre Código: 25872 Referencia: IO15  
Discapacitados Código: 20953 Referencia: IO03  
Toilette Código: 21561 Referencia: IO04  
Prohibido fumar Código: 25873 Referencia: IO16  
Babe change Código: 26874 Referencia: IO21

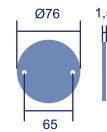

10 udes.

## Pasadores



Pasador de embutir macizo 200mm  
Referencia: PEM/200  
Código: 26840

Pasador de embutir macizo 300mm  
Referencia: PEM/300  
Código: 26841

2 udes.

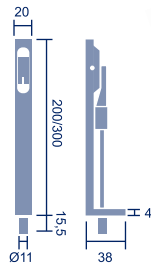

Pasador de embutir 150mm  
Referencia: PE/150  
Código: 26842

Pasador de embutir 200mm  
Referencia: PE/200  
Código: 20228

Pasador de embutir 300mm  
Referencia: PE/300  
Código: 20958

2 udes.



## Soportes pasamanos



Sop. Pasamanos esparrago  
Referencia: SP02/inox  
Código: 26556

1 ud.

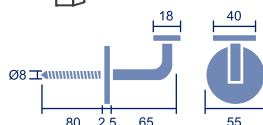

Sop. Pasamanos sobreponer  
Referencia: SP01/inox  
Código: 25257

1 ud.

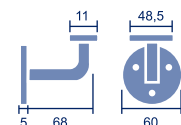

## Topes de puerta



Tope puerta Ø19mm  
Referencia: TP104  
Código: 25499  
20 udes.

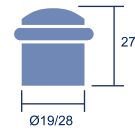

Tope puerta Ø28mm  
Referencia: TP103  
Código: 25498  
5 udes.



Tope puerta Ø24mm  
Referencia: TP102/304  
Código: 26886  
8 udes.

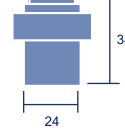

Tope puerta Ø44mm  
Referencia: TP107  
Código: 24999  
10 udes.

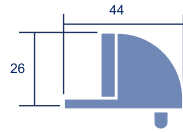

## Placa de limpieza



Placa de limpieza 170mm  
Referencia: PL/170  
Código: 26895

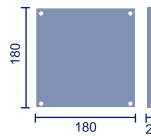

Placa de limpieza 180mm  
Referencia: PL/180  
Código: 21383

10 udes.

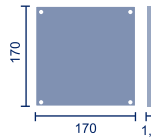

## Pestillo y condena sobreponer



Pestillo sobreponer  
Referencia: I026  
Código: 26877  
10 udes.

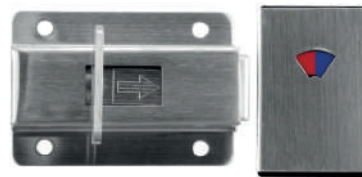
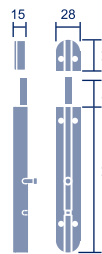

Condena sobreponer  
Referencia: I2297  
Código: 26847

1 ud.

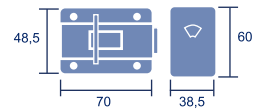

## Retenedor



Retenedor  
Referencia: I023  
Código: 26875  
6 udes.

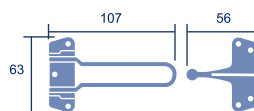

## Tornillo embellecedor



Tornillo embellecedor  
Referencia: I024  
Código: 26876  
200 udes.

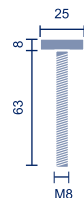

# Accesorios baño

Modelo Lara	28
Modelo Diana	30

## Lara

Toallero 1 barra 450mm  
Referencia: LARA/004-45  
Código: 23430

 1 ud.

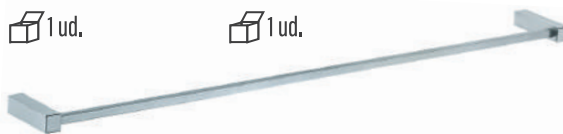

Toallero 1 barra 600mm  
Referencia: LARA/004-60  
Código: 25877

 1 ud.



Toallero 2 barras 450mm  
Referencia: LARA/005-45  
Código: 23431

 1 ud.

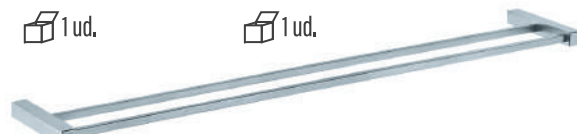

Toallero 2 barras 600mm  
Referencia: LARA/005-60  
Código: 25878

 1 ud.



Toallero 2 barras giratorio 600mm  
Referencia: LARA/006  
Código: 25879

 1 ud.



Toallero anilla  
Referencia: LARA/009  
Código: 25882

 1 ud.

Repisa toallas 600mm  
Referencia: LARA/007  
Código: 25880

 1 ud.



Repisa toallas con barra toallero  
Referencia: LARA/008  
Código: 25881

 1 ud.





Repisa cristal 600mm  
Referencia: LARA/001  
Código: 25874

1 ud.



Jabonera ducha esquina  
Referencia: LARA/018  
Código: 25893

1 ud.



Jabonera ducha  
Referencia: LARA/017  
Código: 25892

1 ud.



Jabonera ducha doble altura  
Referencia: LARA/019  
Código: 25894

1 ud.



Percha 3 ganchos  
Referencia: LARA/016  
Código: 25891

1 ud.



Percha 1 gancho  
Referencia: LARA/014  
Código: 25889

1 ud.



Dosificador jabón sobremesa  
Referencia: LARA/010S  
Código: 25884

1 ud.



Percha 2 ganchos  
Referencia: LARA/015  
Código: 25890

1 ud.



Portarrollo repuesto  
Referencia: LARA/012  
Código: 25886

1 ud.



Dosificador jabón pared  
Referencia: LARA/010P  
Código: 25883

1 ud.



Sop. pared vaso inox  
Referencia: LARA/002  
Código: 25875

1 ud.



Portarrollo  
Referencia: LARA/011  
Código: 25885

1 ud.



Sop. pared vaso cristal  
Referencia: LARA/003  
Código: 25876

1 ud.



Escobillero pared  
Referencia: LARA/013P  
Código: 25887

1 ud.



Escobillero suelo  
Referencia: LARA/013S  
Código: 25888

1 ud.

# Diana

Toallero 1 barra 450mm  
Referencia: DIANA/004-45  
Código: 23432

 1 ud.



Toallero 1 barra 600mm  
Referencia: DIANA/004-60  
Código: 25898

 1 ud.



Toallero 2 barras 450mm  
Referencia: DIANA/005-45  
Código: 23433

 1 ud.



Toallero 2 barras 600mm  
Referencia: DIANA/005-60  
Código: 25899

 1 ud.



Toallero 2 barras giratorio 600mm  
Referencia: DIANA/006  
Código: 25900

 1 ud.



Toallero anilla  
Referencia: DIANA/009  
Código: 25903

 1 ud.

Repisa toallas 600mm  
Referencia: DIANA/007  
Código: 25901

 1 ud.



Repisa toallas con barra toallero  
Referencia: DIANA/008  
Código: 25902

 1 ud.

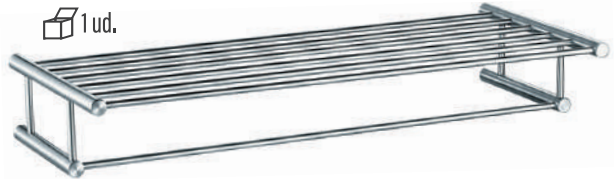

Repisa cristal 600mm  
Referencia: DIANA/001  
Código: 25895

 1 ud.

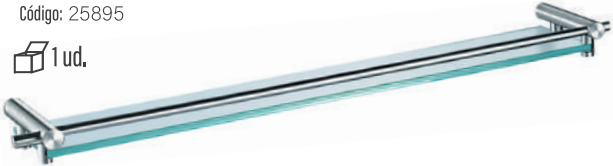

Jabonera ducha esquina  
Referencia: DIANA/018  
Código: 25914

 1 ud.

Jabonera ducha  
Referencia: DIANA/017  
Código: 25913

 1 ud.



Jabonera ducha doble altura  
Referencia: DIANA/019  
Código: 25983

 1 ud.

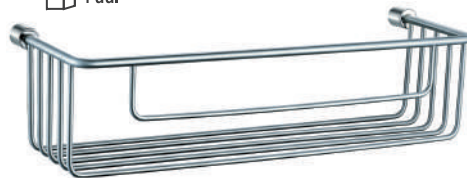

Percha 3 ganchos  
Referencia: DIANA/016  
Código: 25912

 1 ud.



Percha 1 gancho  
Referencia: DIANA/014  
Código: 25910

 1 ud.





Percha 2 ganchos  
Referencia: DIANA/015  
Código: 25911

 1 ud.



Dosificador jabón pared  
Referencia: DIANA/010P  
Código: 25904

 1 ud.



Sop. pared vaso cristal  
Referencia: DIANA/003  
Código: 25897

 1 ud.



Sop. pared vaso inox  
Referencia: DIANA/002  
Código: 25896

 1 ud.



Portarrollo  
Referencia: DIANA/011  
Código: 25906

 1 ud.



Escobillero pared  
Referencia: DIANA/013P  
Código: 25908

 1 ud.

# Estructuras modulares

Soporte lateral	33
Soporte superior	33
Conector de tubo	34
Ángulo de unión	34
Condena	34
Bisagras	34
Soporte a suelo	35
Percha	35
Pomos	35
Barra tubular y perfiles	35

# Barras de apoyo baño

Barra recta 300 y 600mm	36
Barra 135°	36
Barra abatible	36

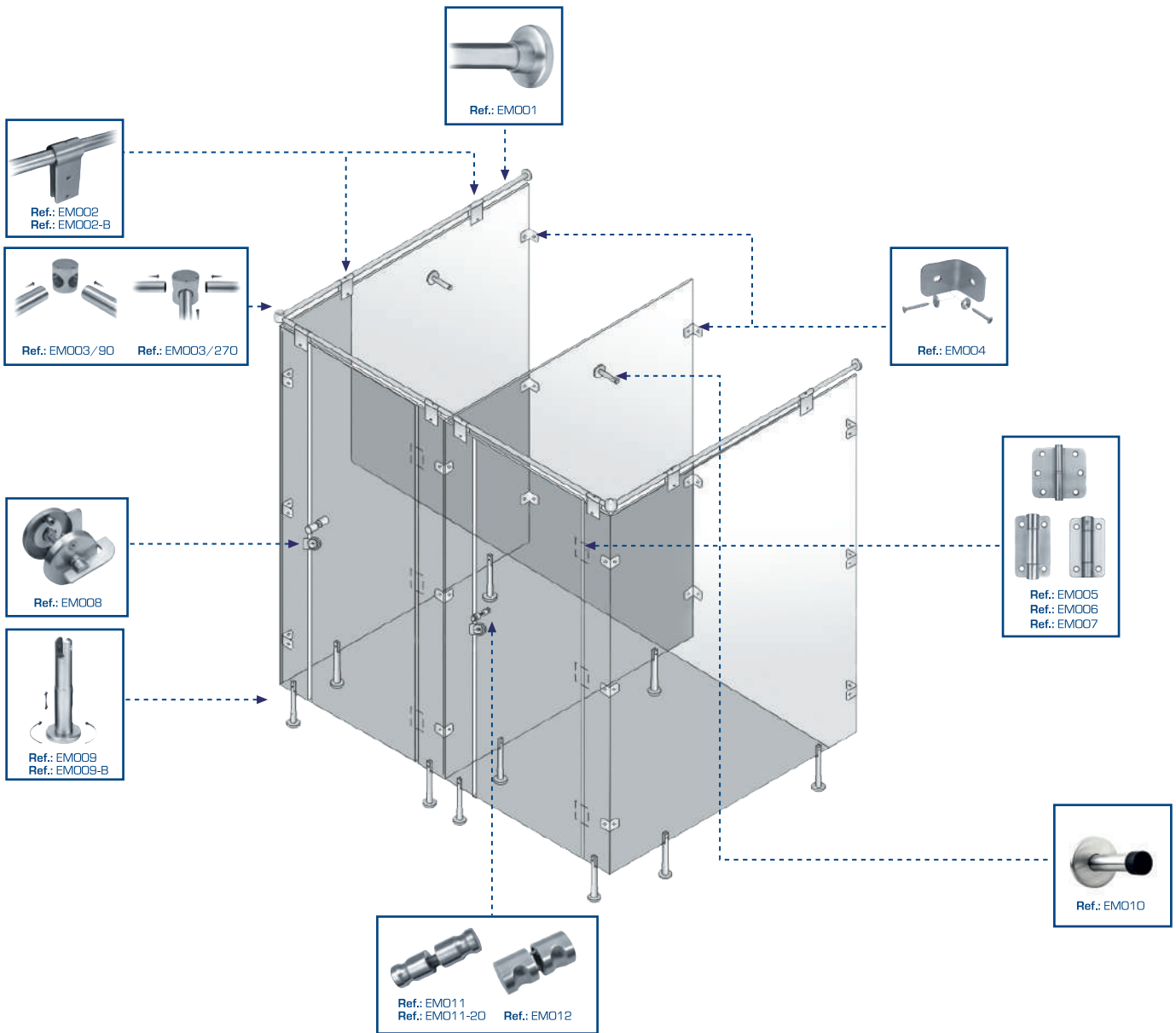

Soporte lateral  
Referencia: EM001  
Código: 23216  
5 udes.

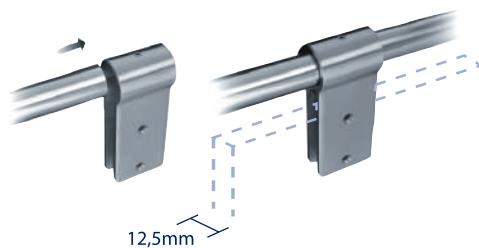
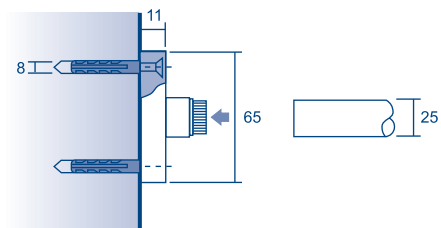

Soporte superior 50mm  
Referencia: EM002  
Código: 23217

Soporte superior 40mm  
Referencia: EM002-B  
Código: 26503  
7 udes.

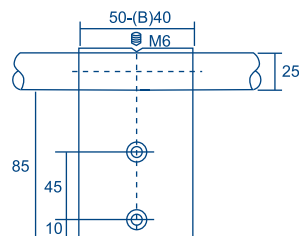

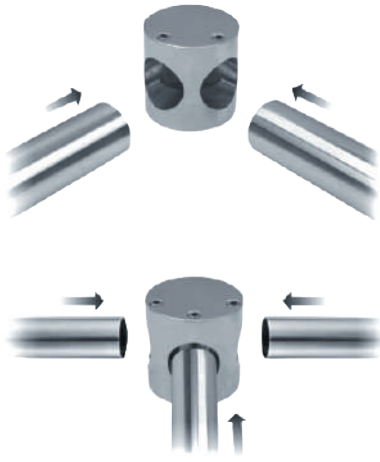

Conector tubo 90°  
Referencia: EM003/90  
Código: 23218

Conector tubo 270°  
Referencia: EM003/270  
Código: 23219

9 udes.

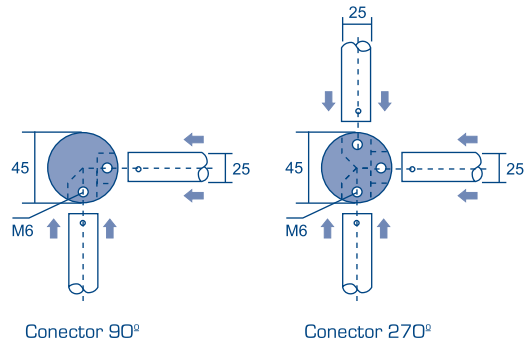

Conector 90°

Conector 270°

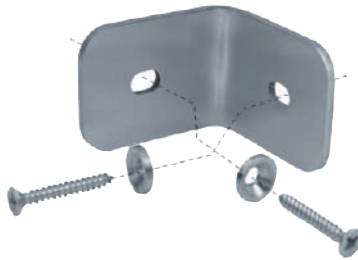

Angulo unión  
Referencia: EM004  
Código: 23220

20 udes.

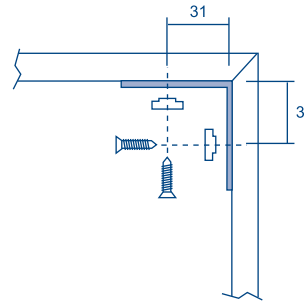

Condensa  
Referencia: EM008  
Código: 23224

5 udes.

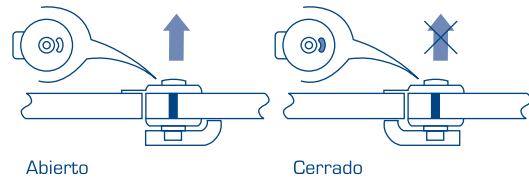

Abierto

Cerrado



Bisagra desmontable, Derecha  
Referencia: EM005/D  
Código: 23221

Bisagra desmontable, Izquierda  
Referencia: EM005/I  
Código: 25270

20 udes.

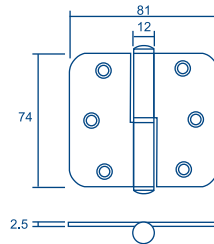

Bisagra fija  
Referencia: EM006  
Código: 23222

20 udes.

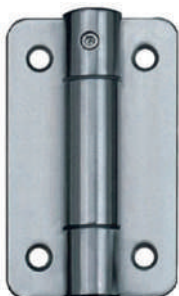
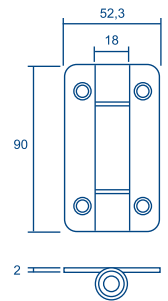

Bisagra fija con muelle  
Referencia: EM007  
Código: 23223

20 udes.

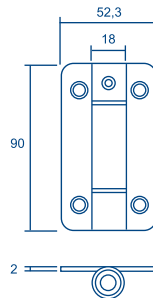





Soporte ajustable nucleo inox  
Referencia: EM009  
Código: 23225

Soporte ajustable nucleo cincado  
Referencia: EM009-B  
Código: 26504

4 udes.

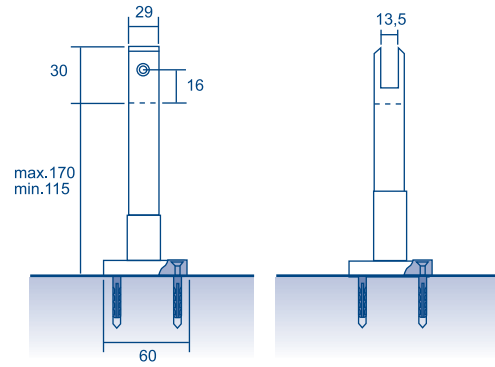

Percha  
Referencia: EM010  
Código: 23226

10 udes.

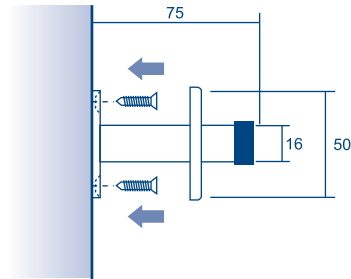

Pomo fijo 20mm  
Referencia: EM011-20  
Código: 26505

Pomo fijo 25mm  
Referencia: EM011  
Código: 23227

10 udes.

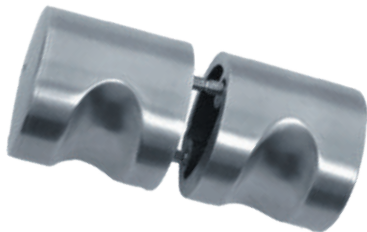
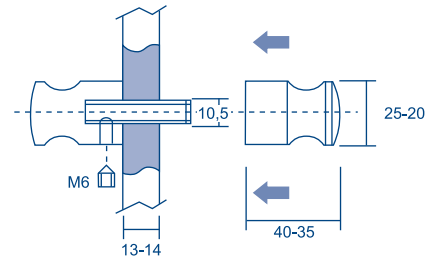

Pomo fijo 52mm  
Referencia: EM012  
Código: 23228

1 ud.

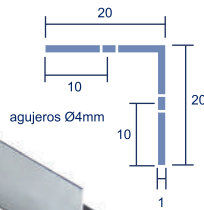
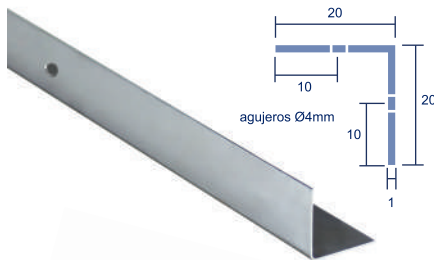
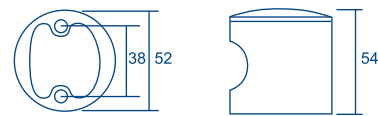

Perfil "L" pul. exterior 1,8m.  
Referencia: EM014  
Código: 26844

Perfil "L" pul. interior 1,8m.  
Referencia: EM013  
Código: 26843

6 udes.

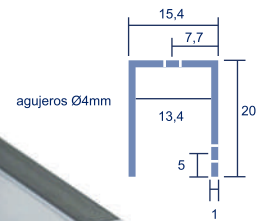

Perfil "U" 1,8m.  
Referencia: EM015  
Código: 26845

6 udes.



Barra tubular 3m.  
Referencia: EM016  
Código: 26846

5 udes.

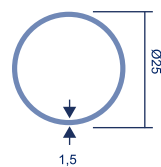



# Barras de apoyo



Barra apoyo recta 300mm  
Referencia: BA001  
Código: 23229

1 ud.

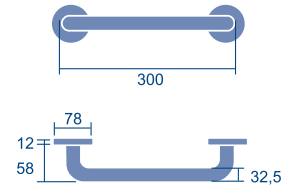

Barra apoyo recta 600mm  
Referencia: BA002  
Código: 23230

1 ud.

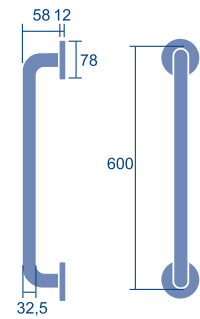
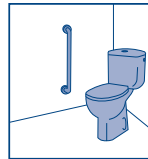

Barra apoyo 135°  
Referencia: BA003  
Código: 23231

1 ud.

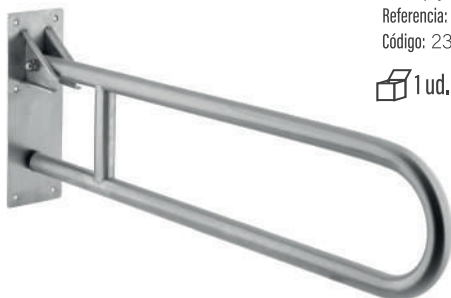
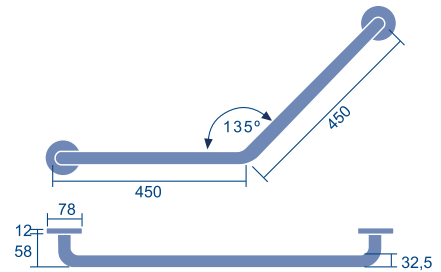

Barra apoyo abatible  
Referencia: BA004  
Código: 23232

1 ud.

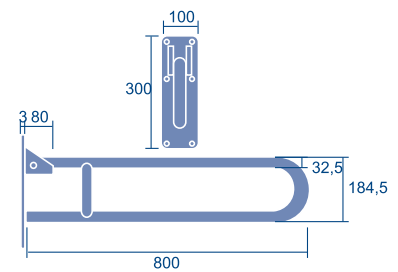
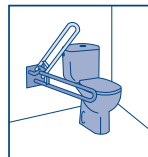

# Bisagras y pernios

Pernio pala ancha	38
Pernio pala estrecha	38
Bisagra quita y pon	38
Bisagra oculta	38
Bisagra simple acción	38
Bisagra doble acción	38
Bisagra antipalanca	39

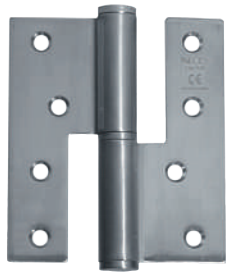

Pernio pala ancha  
canto cuadrado

Referencia: N1086  
Código: 21106. DCHA  
Código: 21107. IZDA

Referencia: N1286  
Código: 21108. DCHA  
Código: 21109. IZDA

10 udes.

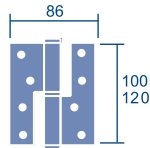

Pernio pala ancha  
canto redondo

Referencia: N1086CR  
Código: 21110. DCHA  
Código: 21111. IZDA

Referencia: N1286CR  
Código: 21112. DCHA  
Código: 21113. IZDA

10 udes.



Pernio pala estrecha  
canto redondo

Referencia: N305inox/100  
Código: 23000. DCHA  
Código: 23001. IZDA

20 udes.

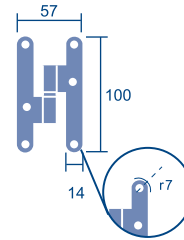

Bisagra quita y pon  
canto cuadrado

Referencia: N9065  
Código: 20376. DCHA  
Código: 20377. IZDA

Referencia: N1065  
Código: 23315. DCHA  
Código: 23316. IZDA

10 udes.

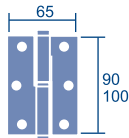

Bisagra quita y pon  
canto redondo

Referencia: N9065CR  
Código: 20283. DCHA  
Código: 20284. IZDA

Referencia: N1065CR  
Código: 23317. DCHA  
Código: 23318. IZDA

10 udes.

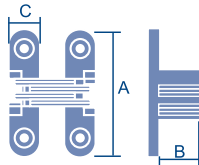
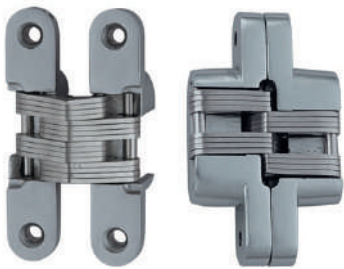
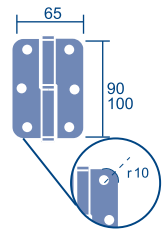

Bisagra oculta. Canto redondo

Código: 22889 Referencia: N820  
Código: 22890 Referencia: N821  
Código: 22891 Referencia: N829  
Código: 22892 Referencia: N830  
Código: 22893 Referencia: N831  
Código: 22894 Referencia: N832

Medidas AxBxC	Ancho puerta	Kg. soportados	10 udes.
45x18x13	20-30mm	5	2 udes.
60x18x13	20-30mm	10	2 udes.
70x18x16	25-35mm	15	2 udes.
95x27x19	30-40mm	25	2 udes.
117x37x25	35-50mm	40	2 udes.
140x50x35	50-70mm	60	2 udes.

\*Se recomienda usar 3 bisagras por puerta, teniendo en cuenta su ancho y su peso.

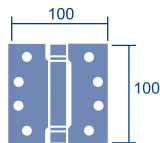

Bisagra simple acción 100mm  
Referencia: N1040  
Código: 21104

2 udes.

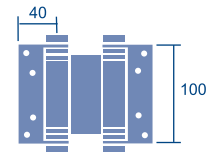

Bisagra doble acción 100mm  
Referencia: N222/100inox  
Código: 23239

2 udes.

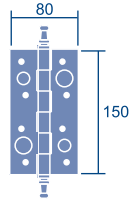

Bisagra antipalanca con remate  
canto cuadrado  
Referencia: N115AI  
Código: 23099

24 udes.

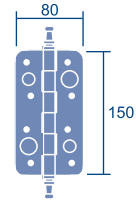

Bisagra antipalanca con remate  
canto redondo

**Radio 12**  
Referencia: N107AI/R12  
Código: 23104

**Radio 16**  
Referencia: N107AI/R16  
Código: 23103

24 udes.

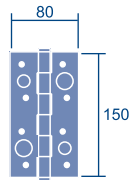

Bisagra antipalanca sin remate  
canto cuadrado  
Referencia: N100AI  
Código: 23100

10 udes.

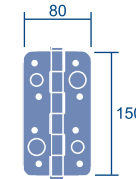

Bisagra antipalanca sin remate  
canto redondo

**Radio 12**  
Referencia: N105AI/R12  
Código: 23102

**Radio 16**  
Referencia: N105AI/R16  
Código: 23101

10 udes.

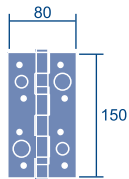

Bisagra antipalanca sin remate  
canto cuadrado con rodaminetos  
Referencia: N100AI-R  
Código: 25921

10 udes.

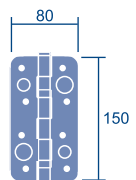

Bisagra antipalanca sin remate  
canto redondo con rodamientos

**Radio 12**  
Referencia: N105AI/R12-R  
Código: 25923

**Radio 16**  
Referencia: N105AI/R16-R  
Código: 25922

10 udes.



# Picaportes y cerraduras

Picaporte unificado	40
Cerradura de entrada	41
Cerradura de seguridad	41

## Picaporte unificado

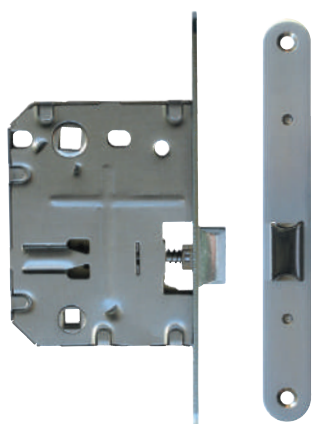

70mm  
Referencia: N134T  
Código: 23713

70mm resbalón silencioso  
Referencia: N134T-SIL  
Código: 23707

10 udes.

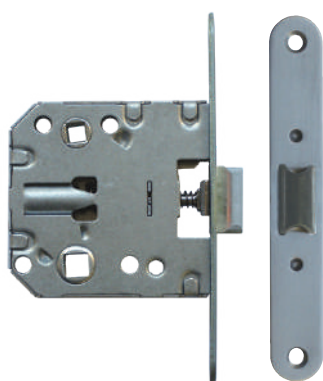
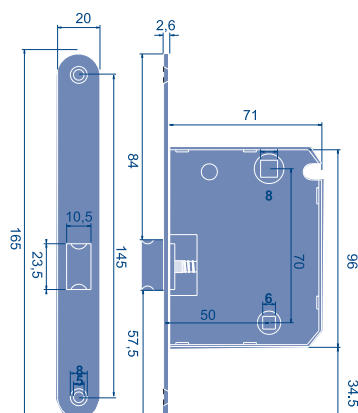

47mm  
Referencia: N6134T  
Código: 23710

47mm resbalón silencioso  
Referencia: N6134T  
Código: 23704

10 udes.

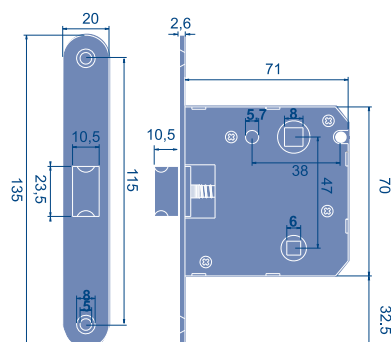



## Cerradura de entrada

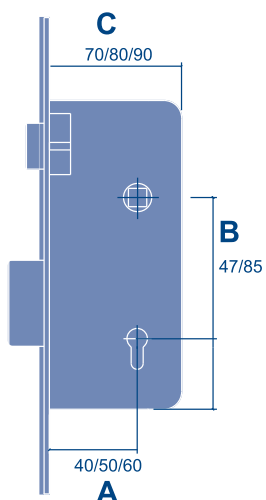
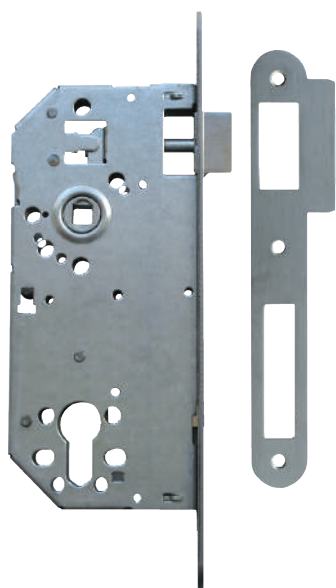

A: Distancia de entrada,  
(Del frente al eje del cuadrado).  
B: Distancia entre ejes.  
C: Ancho de caja.

Cerradura de entrada E.E. 85mm

Código	Referencia	AxBxC	Canto
Código: 26134	Referencia: N30/40CC	40x85x70	cuadrado
Código: 26137	Referencia: N30/40CR	40x85x70	redondo
Código: 26140	Referencia: N30/50CC	50x85x80	cuadrado
Código: 26143	Referencia: N30/50CR	50x85x80	redondo
Código: 26146	Referencia: N30/60CC	60x85x90	cuadrado
Código: 26149	Referencia: N30/60CR	60x85x90	redondo

1 ud.

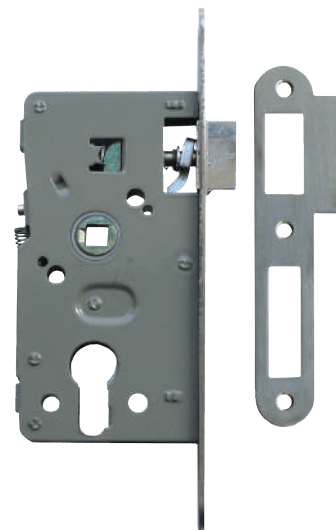

Cerradura de entrada E.E. 47mm

Código	Referencia	AxBxC	Canto
Código: 26116	Referencia: N10P/40CC	40x47x70	cuadrado
Código: 26119	Referencia: N10P/40CR	40x47x70	redondo
Código: 26122	Referencia: N10P/50CC	50x47x80	cuadrado
Código: 26125	Referencia: N10P/50CR	50x47x80	redondo
Código: 26128	Referencia: N10P/60CC	60x47x90	cuadrado
Código: 26131	Referencia: N10P/60CR	60x47x90	redondo

1 ud.

## Cerradura de seguridad

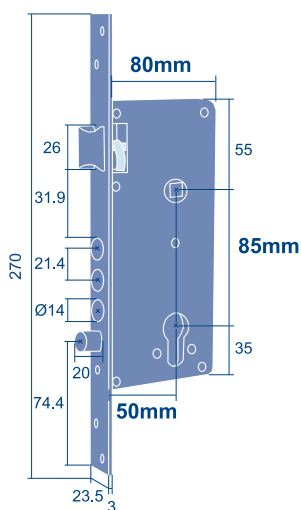
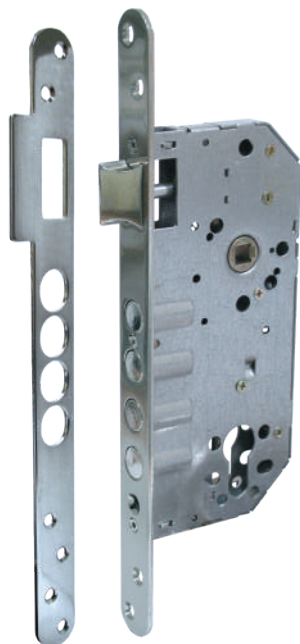

Escudo abierto

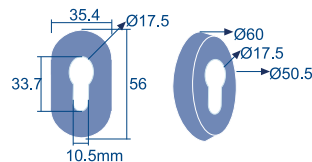

Cerradura seguridad E.E. 85mm

Código	Referencia	Medidas	Canto
Código: 26112	Referencia: NX100CCAI	50x85x80	cuadrado
Código: 26113	Referencia: NX100CRAI	50x85x80	redondo

Escudo cerrado

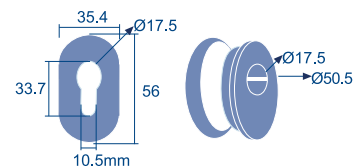

Cerradura seguridad E.E. 85mm

Código	Referencia	Medidas	Canto
Código: 26108	Referencia: NX200CCAI	50x85x80	cuadrado
Código: 26109	Referencia: NX200CRAI	50x85x80	redondo

# Tiradores para mueble

Tiradores embutir	42
Tirador armario y maletero	43
Asas para mueble	43
Pomos para mueble	44

## Tiradores embutir

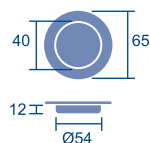

Tirador embutir circular  
Referencia: I008  
Código: 20954

10 udes.

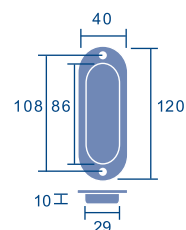

Tirador embutir ovalado  
Referencia: I007  
Código: 20955

10 udes.

Tirador embutir rectangular  
Referencia: I020

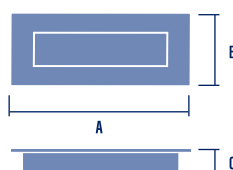

	A	B	C	
Código: 26552	100	50	12	10 udes.
Código: 26596	120	40	13	20 udes.
Código: 26566	150	50	14,5	10 udes.
Código: 26553	300	37	12	7 udes.

# Tirador armario y maletero

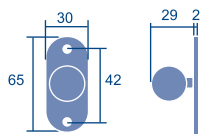

Tirador maletero  
Referencia: I018  
Código: 25946

20 udes.

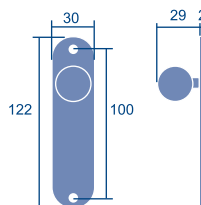

Tirador armario  
Referencia: I017  
Código: 25945

20 udes.

# Asas mueble



Asa mueble  
Referencia: AMI 01/304  
Código: 24432

20 udes.

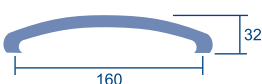

Asa mueble  
Referencia: AMI 02/304  
Código: 24433

20 udes.

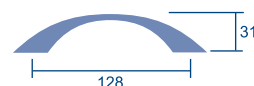

Asa mueble Ø12mm  
Referencia: AMI 12/202

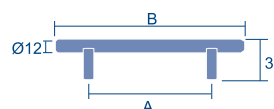

Cód.:	A	B		Cód.:	A	B		Cód.:	A	B		Cód.:	A	B	
23098	96	160	50	22811	288	352	30	25740	512	576	10	25746	736	800	10
22808	128	192	50	25737	320	384	10	25741	544	608	10	25747	768	832	10
22809	160	224	50	22921	352	392	10	25742	576	640	10	25748	832	896	10
21655	192	256	50	22812	384	448	20	25743	608	672	10	25749	896	960	10
22810	224	288	40	25738	416	480	20	25744	640	704	10	25750	960	1024	10
23113	256	320	25	22813	448	512	20	22814	672	736	10	22815	1184	1248	10
				25739	480	544	20	25745	704	768	10	25751	1376	1440	10



Asa mueble cuadrada 12mm  
Referencia: AMI 12C/202

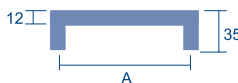

Cód.:	A	
25786	96	25
25787	128	25
25788	160	25
25789	192	25
25790	224	25
25791	256	25
25792	288	25
25793	320	25
24521	512	25
24522	608	25
24523	704	25

# Pomos mueble



	A	B	
Cód.: 24434	20	25,5	20
Cód.: 24435	25	31	20

Referencia: PMI 01/304

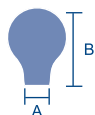

	A	B	
Cód.: 24453	10	20	50
Cód.: 24436	15	26	50
Cód.: 24437	20	28	20
Cód.: 24452	25	30	20

Referencia: PMI 02/304



	A	B	
Cód.: 24438	11	25,5	50
Cód.: 24439	20	30	20

Referencia: PMI 03/304

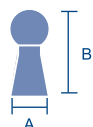

	A	B	
Cód.: 24440	15	24	50
Cód.: 24441	20	26	20

Referencia: PMI 04/304

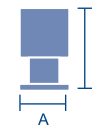

Referencia: PMI 05/304  
Código: 24442

20 udes.

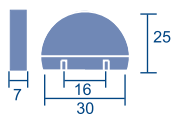

	A	B	
Cód.: 24443	15	22	50
Cód.: 24163	20	30	20

Referencia: PMI 06/304



	A	B	C	
Cód.: 24444	20	17	13	20
Cód.: 24445	30	25	20	20
Cód.: 24446	40	34	26	20

Referencia: PMI 07/304

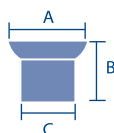

	A	B	
Cód.: 24447	20	21,5	20
Cód.: 24448	25	25	20

Referencia: PMI 08/304

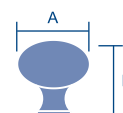

	A	B	C	
Cód.: 24449	20	26	10	20
Cód.: 24450	25	30	12	20
Cód.: 24451	30	37	14	20

Referencia: PMI 09/304



	A	B	
Cód.: 26562	20	31	10
Cód.: 26561	25	38	10

Referencia: PMI 10/304







